

## A multilevel model for description of thermomechanical fracture of refractory linings of high-temperature equipment

Andrey Zabolotskii<sup>1</sup>, Vladislav Khadyev<sup>1</sup>, Andrey Dmitriev<sup>2</sup>, Evgeny Shilko<sup>2</sup>

<sup>1</sup> Magnezit Group, Ltd., Russia

<sup>2</sup> Institute of Strength Physics and Materials Science of Siberian Branch of Russian Academy of Sciences, Russia

---

### Article Info

#### Article history:

Received September 11, 2022

Revised November 23, 2022

Accepted December 28, 2022

#### Keywords:

Refractory,  
High-temperature equipment,  
Linings,  
Fracture,  
Finite-elements method.

---

### ABSTRACT

The paper considers the issue of determining the resource of refractory linings of high-temperature industrial units by mathematical modeling of crack growth in the framework of a multilevel approach. The study was carried out using the finite element simulation and experimental data on the thermophysical and mechanical characteristics of refractory. At the level of lining, zones of increased cracking (areas with the highest level of thermally induced stresses and strains) were identified. Next, on the scales of individual products and representative volumes of refractory material, crack growth was simulated with use of previously calculated stresses and strains in the lining as boundary conditions. The relationship between thermal impact on the refractory lining of equipment and its stress-strain state is shown. Taking into account the known stress-strain state, the method for determining the direction of crack growth is considered.

*Copyright © 2022 Regional Association for Security and crisis management and European centre for operational research.  
All rights reserved.*

---

### Corresponding Author:

Andrey I. Dmitriev,  
Institute of Strength Physics and Materials Science SB RAS.  
Email: [dmitr@ispms.ru](mailto:dmitr@ispms.ru)

---

## 1. Introduction

Refractory materials, which are ceramics used at high temperature, are extensively used in metallurgy, cement manufacturing and oil refinery (Kingery, 1960; Sadik et al., 2016; Lee & Moore, 1998). The characteristic feature of operation of these materials is the temperature gradient inside lining arising from the fixing conditions, which results in the appearance of a certain stress pattern (Nomura & Uchida, 2000; Gasser & Boisse, 2001). As shown by Shi et al. (2013) the latter favors crack propagation in the areas of stress concentration such as pores, microcracks and interfaces between reinforcing grains of the material with the binding matrix. According to Ning et al. (2014) and Sajjadi et al. (2016) the zone of crack initiation in the refractory material and the direction of crack propagation are governed by different factors such as sufficiently high stress or elastic strains in the stress concentration areas, mutual locations and distance between the stress concentrators, stress distribution. Particularly, it has been shown that cracks primarily propagate along the gradient of elastic strains from the region of tension to that of compression (Kuliev & Morozov, 2016).

It should be noted that elastic properties of the refractory materials have pronounced temperature dependence (Lu & Fleck, 1998). Andreev et al. (2020) and Zhu et al. (2017) showed that at low temperatures they are subjected to brittle or quasibrittle (fatigue) fracture, while at high temperatures stress relaxation occurs by means of plastic flow of the material (Varshneya et al., 1990, Zabolotskii, 2011). The fatigue nature of fracture of the brittle ceramics is caused by a large amount of structure defects and phase interfaces, which, on the one hand, serve stress concentrators and source of crack nucleation, but, on the other hand, are obstacles to the crack propagation, which stop it at a certain stress level (Andreev et al., 2020; Goldstein & Perelmuter,

1999; Perelmuter, 2020; Goldstein & Osipenko, 2019). Thus, the complexity of description of the thermomechanical behavior of the refractory materials under operation are induced by a large variety of interrelated factors, including both the heterogeneous hierarchical structure of the material and the temperature gradient and complex stress distribution.

Recent studies done by Andreev et al. (2021, 2012) showed that one of the most effective tools to investigate the thermomechanical behavior of the refractory lining operating at high temperatures can be computer simulation. As a rule, mathematical simulation of refractory materials is used to reveal potential zones of fracture at the stage of designing aggregates to reduce the effect of mechanical stresses by means of changing their structure or using thermocompensators. The other direction of the numerical studies is concerned with prediction of material resistance under the conditions of manufacturing. Apparently, the strongest effect of application of the computer simulation to predict wear resistance of the refractory materials can be achieved by using a multilevel approach, which provides revealing of the zone of the highest stresses and temperatures corresponding to the brittle fracture at the “equipment” (lining) level, and then simulation of the crack propagation at the levels of the “individual product” or “material structure”. This approach allows determining the service life of the lining before the formation of defects with a size inadmissible for its operation.

The authors have previously simulated macrocrack formation in refractory lining elements under the conditions of complex temperature gradients and mechanical confinement corresponding to real industrial aggregates. Finite Element Method (FEM, ANSYS Mechanical) and Discrete Element Method (DEM) have been used for the simulations (Grigoriev et al., 2022). The present study deals with the application of the multilevel approach for revealing the mechanisms underlying cracking of the refractory materials in industrial high-temperature aggregates. The issues concerned the crack propagation in a quasibrittle material under the condition of temperature gradients are considered.

## 2. A multilevel model description

General view of the refractory lining at the level of “equipment” is shown in Figure 1. Because of their small thickness, the heat-insulating layer (2) and buffer layer (4) in the FEM model were substituted by heat resistors and corresponding mechanical conditions at the interfaces between neighbor layers. This allowed us to decrease the number of elements of the computational grid to  $4 \times 10^5$  hexagonal elements.

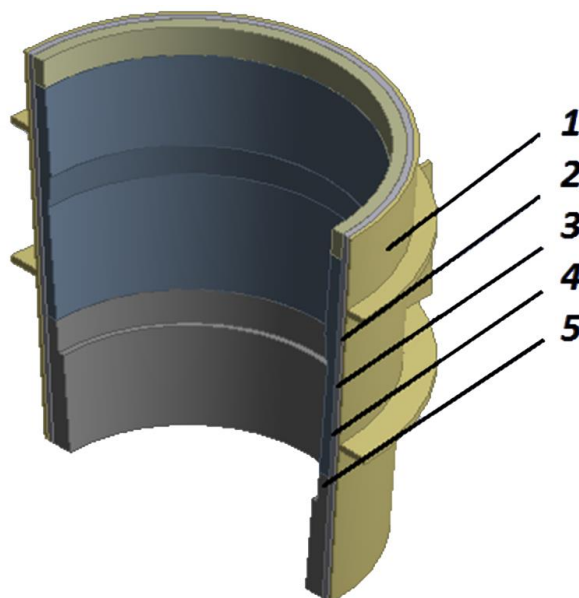

**Figure 1.** A scheme of the refractory lining of a high-temperature unit: 1 - casing with external structural elements, 2 - heat-insulating layer, 3 - control lining, 4 - buffer layer (filling), 5 - working lining.

The working lining (facing the inside of the aggregate) is represented by a material, which is brittle at normal conditions and ductile at temperatures above 1400 °C. The temperature inside the aggregate was cyclically varied from 1100 to 1700 °C in accordance with cycles of metal working. The model took into

account heat exchange through the lining by using boundary conditions of second and third types. The characteristics of the materials of the multilayer lining are listed in Table 1.

**Table 1.** Properties of lining materials used in calculations

Properties	Unit	Periclase carbon refractory	Buffer layer	Fireclay	Thermal insulation	Steel
Density	kg·m <sup>-3</sup>	3000	1500	2000	300	7850
Thermal expansion coefficient	K <sup>-1</sup>	10×10 <sup>-6</sup>	-	6×10 <sup>-6</sup>	-	12×10 <sup>-6</sup>
Elastic modulus	GPa	10	1	2	0,1	200
Poisson's ratio	-	0.18	0.2-0.4	0.18	0.4	0.3
Thermal conductivity	W·m <sup>-1</sup> ·K <sup>-1</sup>	10	3	1	0.2	60.5
Heat capacity	J·rg <sup>-1</sup> ·K <sup>-1</sup>	1000	1200	880	1100	460
Thickness	mm	200	40	120	20	40
Compressive strength	MPa	40	-	20	0,5	150
Flexural strength	MPa	4	-	5	-	-
Ultimate strain	%	0.4	-	-	-	-

Since active heat exchange at the aggregate casing surface results in appearance of “cold” areas at the sites of attachment of external elements, more intensive cooling of the back side of the working lining can occur in these areas in case of the absence of the heat-insulating layer or its significant wear (Figure 2). On the other hand, the attachment conditions of the refractory in the lining are also determined by elastic characteristics of its auxiliary layers. For example, the buffer layer can be compressible enough not to hinder thermal expansion of the refractory materials of the working lining. In some cases, vice versa the buffer layer may be not used or its compressibility can be insufficient.

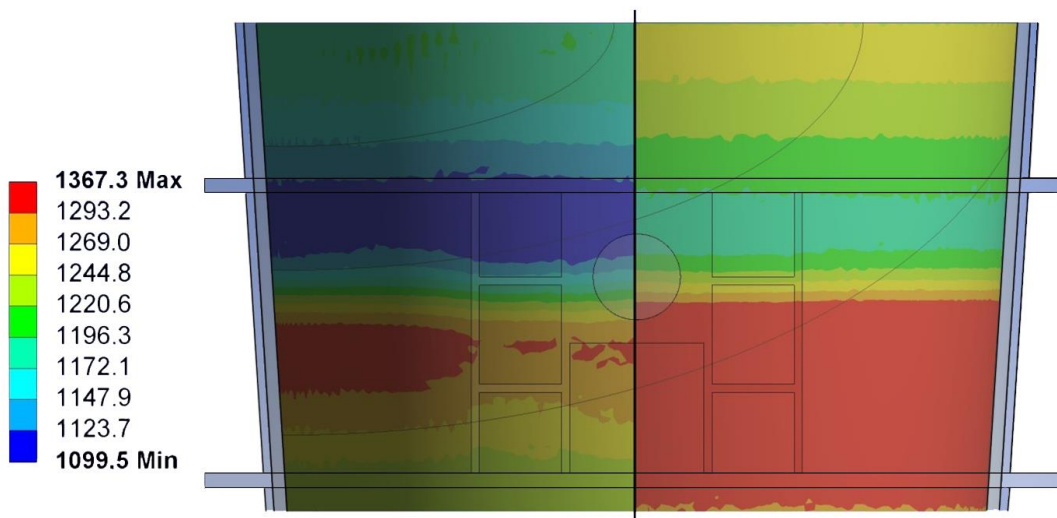

**Figure 2.** Temperature distribution of the on the back surface of the working lining with worn (left) and design (right) thermal insulation.

The working lining (facing the inside of the equipment) is represented by a material, which is brittle under normal conditions and plastic at temperatures above 1400°C. The temperature inside the aggregate was cyclically varied from 1100 to 1700°C in accordance with cycles of metal working. In addition, the model considered heat exchange through the lining by using boundary conditions of second and third types. The characteristics of the materials of the multilayer lining are listed in Table 1.

Since active heat exchange at the aggregate casing surface results in appearance of “cold” areas at the sites of attachment of external elements, more intensive cooling of the back side of the working lining can occur in these areas in case of the absence of the heat-insulating layer or its significant wear (Figure 2). On the other hand, the attachment conditions of the refractory materials in the lining are also determined by elastic characteristics of its auxiliary layers. For example, the buffer layer can be compressible enough not to hinder

thermal expansion of the refractory materials of the working lining. In some cases, vice versa the buffer layer may be not used or its compressibility can be insufficient.

Two different boundary conditions for the back side of the lining were considered in the numerical model to study this issue. The first one implied the absence of the temperature gradient at the back side and allowed its free movement. The second one modelled a stiff buffer layer, which does not allow stress relaxation at the back side.

One more factor controlling the stress-strain state of the working lining is the lateral constraint, which is induced by the adjacent bricks for the considered brick of the lining. In the proposed FEM model the lateral constraint at the level of an individual product was considered by elastic fixing of the brick on four lateral sides. Stiffness of the support was approximately determined by using typical properties of the brick material and lining geometry.

It is obvious that the integral pattern of the stress-strain distribution, which is formed as a result of thermomechanical action, cannot fully predict the service life of a refractory material. A reliable prediction of the thermomechanical behavior of a refractory requires explicit consideration of the features of its complex hierarchical structure. To build a model of a lining fragment at the level of “structure”, the results of microscopic examination were used. It can be seen from Figure 3, which depicts a fragment of the fracture surface, that the microstructure of the refractory material is comprised of reinforcing grains with a characteristic size from 1 to 6 mm and a porous binder. According to the data obtained by electron microscopy, the voids typically have spherical or elongated oval form with 1:3 width-to-length ratio up to 100  $\mu\text{m}$  in size.

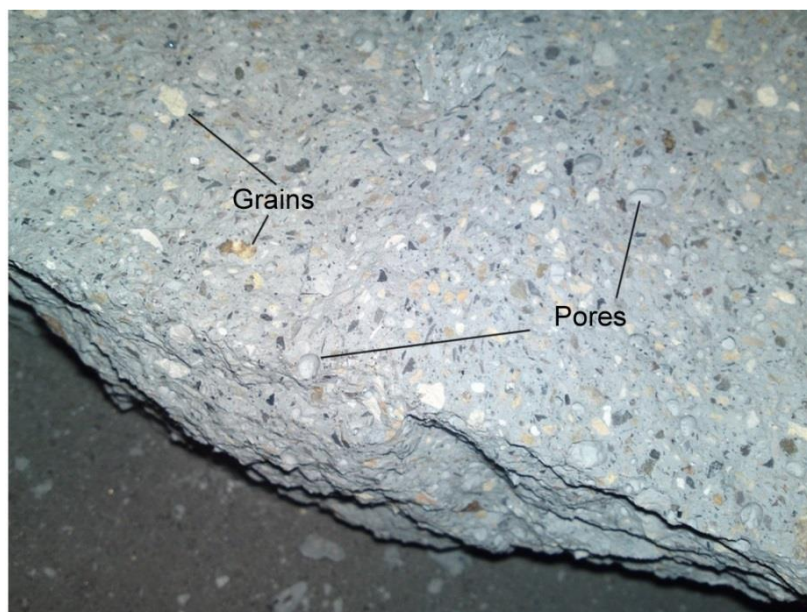

**Figure 3.** Typical fracture surface of a refractory material.

At the level of “structure” we modelled a fragment of the matrix containing a group of pores, which were assumed spherical voids of the same size. The pores were located at the nodes of a face-centered cubic lattice, the size of which varied in different calculations. The following variants of load application were set: uniaxial, biaxial and triaxial. Uniaxial or biaxial loading is implemented in most industrial units due to thermal expansion of materials under constrained conditions. A triaxial type of load may occur due to thermal expansion of products with a certain geometric shape of equipment or its elements.

According to the available experimental results by Zabolotskii (2011), Zabolotskiy et al. (2020) and Stueckelschweiger et al. (2019), the refractory material undergoes the phase transformation at a temperature of  $\sim 1400$   $^{\circ}\text{C}$ , which is concerned with appearance of a liquid phase (melting of eutectic phases and surface phenomena in fine grains). This transition manifests itself in the change of the fracture pattern from brittle to ductile. This change was considered in the numerical model at the level of “structure” by elimination of the area of the material with temperature above  $1400^{\circ}\text{C}$  from the simulation of the brittle fracture.

### 3. Simulation results and discussion

#### 3.1. “Equipment” level

The most stressed areas of the lining, which should be zones of primary crack nucleation, were determined during the simulation at the “equipment” level. According to the results, these areas are determined by design features of the lining, namely with regions of intensive cooling or those subjected to external mechanical loading. It was found that the equipment size factor could influence crack localization. Stochastic crack distribution is characteristic for small ladles, while in the case of large ladles, cracks predominantly nucleate in some most stressed areas due to stress superposition. Figure 4 shows maximum stress in the lining as a function of ladle size (radius) at the fixed lining thickness and of the lining thickness at the fixed radius of the ladle. It is seen that both dependences are non-linear but exhibit opposite trends. An increase in the lining thickness results in a reduction in the maximum stress, whereas an increase in the equipment (aggregate) radius leads to an increase in the mechanical stress.

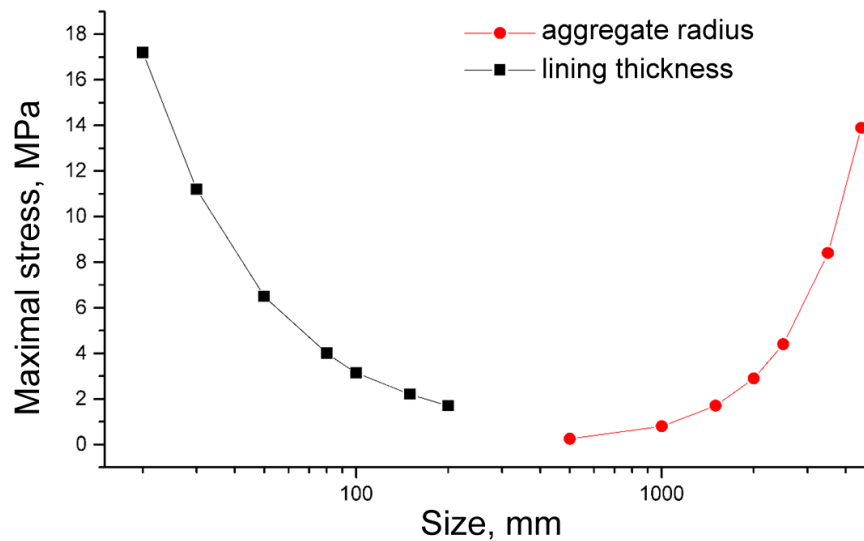
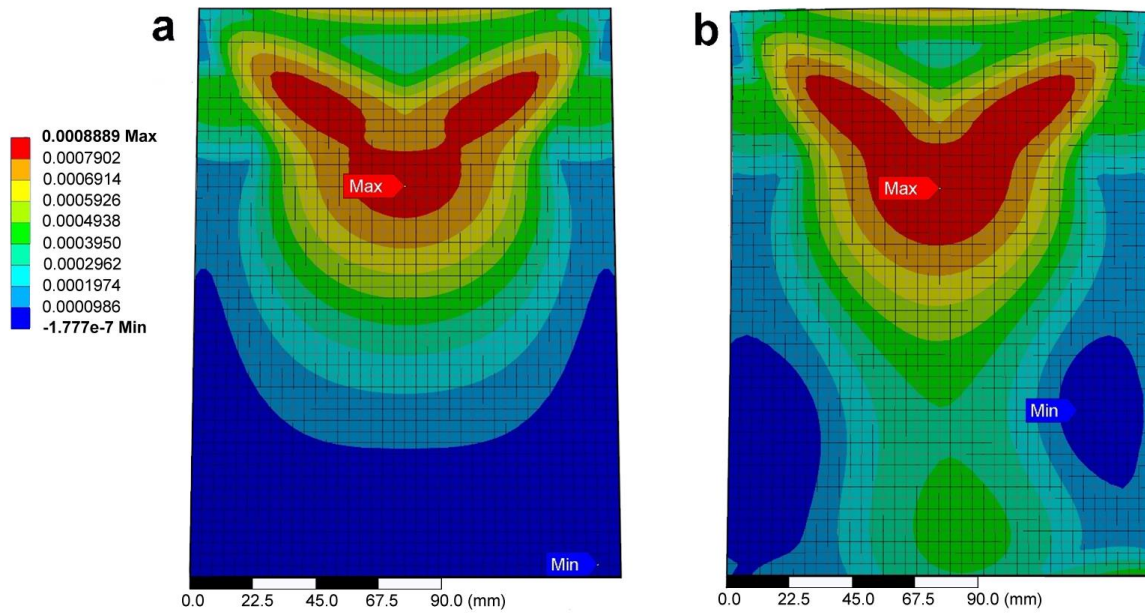

**Figure 4.** Dependence of maximum stresses in the lining on its characteristic size at fixed lining thickness (red points) and on the lining thickness at fixed characteristic size of the ladle (black points).

The revealed effects of the size of the steelmaking equipment and its lining require preliminary simulations at the “equipment” level in order to determine the potential cracking pattern. These results can be used as boundary conditions to determine the initial stress-strain distribution in the lower level models, i.e. at the “product” and “structure” levels. The simulation results obtained using the smaller scale models will make it possible to judge with a high degree of confidence about the possibility of crack nucleation and propagation.

#### 3.2. “Product” level

Figure 5 shows elastic strains in the model of the “product” level for the two considered cases of the boundary conditions at the back side of the lining. The specific temperature distribution patterns in both cases were determined from the solution of the task at the “equipment” level. In the first case, refractory product (“brick”) is located far from the zone of intensive cooling of the casing, and the temperature gradient is absent. In the second case, which simulates either the wear of the heat-insulating layer or the product location close to the structural elements of the casing, the temperature difference at the back surface of the lining is equal to 100 °C. Evidently, in the first case the strain pattern would be symmetrical relative to the central axis of the product, as shown in Figure 5a, whereas in the second case the strain gradient deflects to the right, i.e. towards higher temperature at the back surface. In the case of crack formation in the product, crack is expected to follow this direction.



**Figure 5.** Distribution of elastic strains in an individual refractory product: a) the same temperature on the back face with the possibility of back face movement; b) the presence of a temperature gradient and hinged fastening of the back face.

### 3.3. "Structure" level

Modeling at the "structure" level showed that the distance between the pores, as well as the properties of the matrix, have a significant impact on the location of the crack initiation point and the direction of its growth. When the distance between the pores exceeds pore size, the pores manifest themselves as independent. In the case of uniaxial and biaxial loading, the direction of crack development depends on the properties of the matrix. For brittle-like materials (Poisson's ratio is less than 0.2), in the case of uniaxial loading, this direction is parallel to the loading axis, while in the case of biaxial loading, it lies in the plane of action of the external forces. For ductile-like materials (Poisson's ratio is more than 0.3) crack is oriented perpendicular to the direction of the load (uniaxial loading) or to both loading axes (biaxial loading). If the pores are close to each other (the distance between the pores is commensurate with the radius of the defect), fracture can initiate at arbitrary angles with respect to the loading axes (Figure 6). The critical value of the distance at which the deterministic failure mode switches to arbitrary is about one pore radius for ductile materials and more than 4 radii for brittle ones. In the case of triaxial loading, the direction of crack development also depends on the distance between pores. At small distances, it is directed inside the system, and at large values, there is no predominant direction.

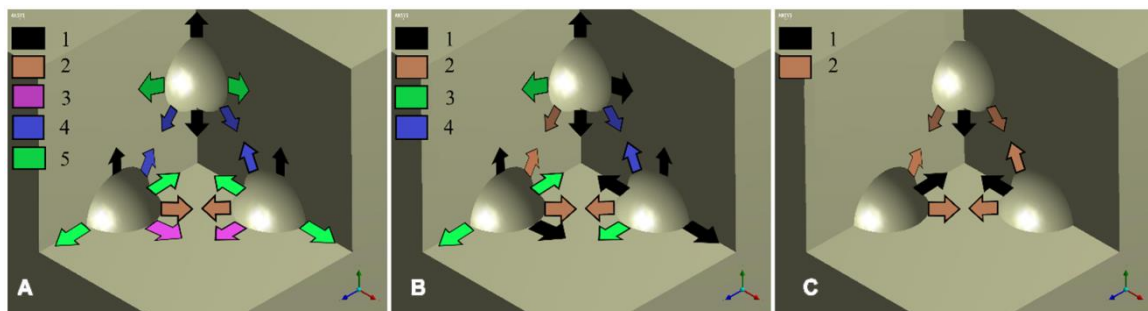

**Figure 6.** Variants of crack development during axial compression of a cubic sample with regularly arranged internal pores: a) uniaxial compression along the Y axis, b) biaxial compression along the X and Y axes, c) triaxial compression. The numbers indicate the possible directions of crack growth depending on the distance between pores and material properties. The elastic strain gradient criterion of fracture is used for calculations (Zabolotskiy et al., in press).

It should also be noted that the distances between pores have a significant effect on the level of stresses and elastic strains in the vicinity of stress concentrators. The obtained dependence of the maximum plastic strains on the distance between the pores has a power-law character. Figure 7 shows such a dependence for materials with different Poisson's ratios. In this case, Young's modulus for all considered materials was 30 GPa. Change in the value of Young's modulus does not lead to a change in the form of the dependence.

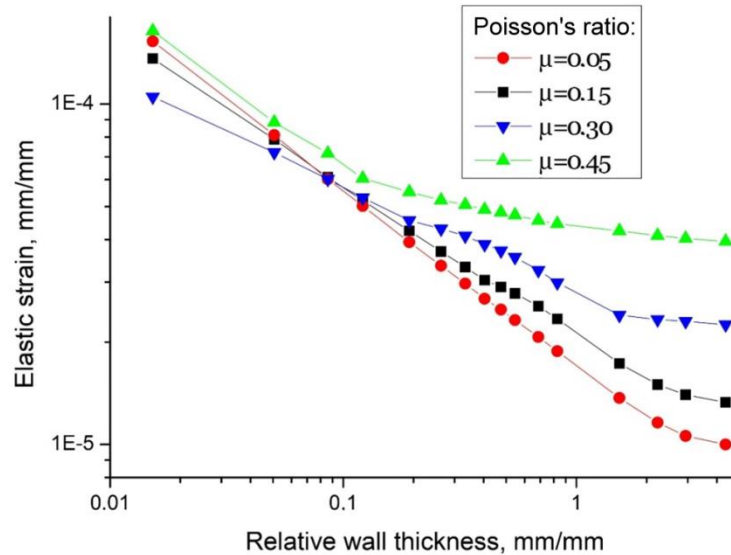

**Figure 7.** Dependences of the maximum elastic strain on the distance between pores for materials with different Poisson's ratios.

Further study of the crack growth dynamics involves the use of an energy approach, in which the energy of elastic strains is spent for the formation of new surfaces and thermal or acoustic emission. The energy of elastic strain of the material in this case can be expressed in terms of mechanical stresses in the deformation zone or the values of the actual strains:

$$U = \frac{\sigma^2 \cdot V}{2 \cdot E} = \frac{E \cdot V}{2} \cdot \varepsilon^2, \tag{1}$$

where V – is the volume of material for which the energy value is calculated,  $\sigma$  - are mechanical stresses, E – is Young's modulus and  $\varepsilon$  – are elastic strains.

Thus, due to the multiscale structure of refractory materials, the formation of a macrocrack in the refractory lining is a complex bottom-up process. At the “structure” level, crack formation is determined by the average distance between the reinforcing grains and between adjacent defects in matrix (structural data can be determined by various methods including electron microscopy). The obtained data on the structure can be used for numerical analysis of the orientation and average length of cracks bounded by the reinforcing large grains (stable mesocracks). Formation of multiple mesocracks corresponds to the stage of quasi-brittle fracture of refractory materials. The completion of this stage is associated with the formation of macrocracks by merging mesocracks through the matrix and interfaces or through the reinforcing particles. The formation of a macrocrack corresponds to the degradation of the performance of the refractory product to such an extent that its use as an element of refractory lining becomes inadmissible.

The condition for the transition from meso- to macro-fracture is determined by the mechanism of mesocrack merging (through matrix and interfaces or through large reinforcing grains). The numerical study of the formation of a cracked structure done by Grigoriev et al. (2021) and experimental data have shown that the main path of crack propagation in refractories is along the interfaces between large grains and the matrix, or through the matrix. It is obvious that large grains in most cases are insurmountable obstacles in the path of a crack, which is consistent with the results done by Romanov & Vladimirov (1992) and Gutkin et al. (2007). They showed that crack propagation through a grain in a ceramic material is possible only in a narrow range of spatial angles under which the growing crack interacts with the surface grains.

#### 4. Concluding remarks

The paper proposes a multilevel approach, which considers the levels of "equipment", "product" and "structure", to determine the refractory resource in an industrial unit by successively reducing the scale of the problem being solved. At the initial stage, the most stressed and strained zones of the lining are determined by the analysis of numerically calculated distributions of stresses and strains. Further, the obtained result serves as boundary conditions either for direct crack growth simulation or for determination of material life by analyzing the existing stress pattern. In any case, it is assumed that fracture (the formation of a crack surface) occurs due to the energy of elastic deformation of the material.

To determine the direction of crack growth, the criterion of elastic strain gradient was used. It is shown that for the large-scale models (levels of "equipment" and "product") the direction of crack growth is determined by the pattern of the temperature and strain fields and can be inclined in the case of a gradient of these parameters on the end face of the product. In turn, by modeling at the "structure" level, it was found that the arrangement of structure inhomogeneities in the refractory material also has a significant influence on the direction of microcrack growth. The use of the energy approach within explicit numerical modeling of crack dynamics makes it possible to predict the scenarios of crack evolution when the crack tip meets neighboring pores or reinforcing grains of the material.

Thus, the information obtained on the basis of computer simulation on the initiation and growth of cracks in refractory materials makes it possible to assess their service life. At present, this is among the topical and still unsolved problems of industrial operation of high-temperature equipment.

**Acknowledgement:** The paper is a part of the research done within the grant 22-19-00688 by the Russian Science Foundation.

#### References

- Andreev, K., Sinnema, S., Rekik, A., Allaoui, S., Blond, E. & Gasser, A. (2012). Compressive behaviour of dry joints in refractory ceramic masonry. *Construction and Building Materials*, 34, 402-408. <https://doi.org/10.1016/j.conbuildmat.2012.02.024>
- Andreev K., Luchini B., Rodrigues M.J. & Lino Alves, J. (2020). Role of fatigue in damage development of refractories under thermal shock loads of different intensity. *Ceramics International*, 46(13), 20707-20716. <https://doi.org/10.1016/j.ceramint.2020.04.235>.
- Andreev, K., Yin, Y., Luchini, B. & Sabirov, I. (2021). Failure of refractory masonry material under monotonic and cyclic loading – Crack propagation analysis. *Construction and Building Materials*, 299, 124-203. <https://doi.org/10.1016/j.conbuildmat.2021.124203>
- Gasser, A. & Boisse, P. (2001). Experimental and Numerical Analyses of Thermomechanical Refractory Lining Behaviour. *Proceedings of the Institution of Mechanical Engineers*, 41-53.
- Goldstein R. V. & Perelmuter M. N. (1999). Modeling of bonding at an interface crack. *International Journal of Fracture*, 99(1-2), 53-79. <https://doi.org/10.1023/A:1018382321949>
- Goldstein, R.V. & Osipenko, N.M. (2019). About Compression Fracture. *Physical Mesomechanics*, 22, 439-455. <https://doi.org/10.1134/S1029959919060018>
- Grigoriev, A.S., Zabolotskiy, A.V., Shilko, E.V., Dmitriev, A.I. & Andreev, K. (2021). Analysis of the Quasi-Static and Dynamic Fracture of the Silica Refractory Using the Mesoscale Discrete Element Modelling. *Materials*, 14, 7376. <https://doi.org/10.3390/ma14237376>
- Grigoriev, A.S., Danilchenko, S.V., Dmitriev, A.I., Zabolotskii, A.V., Migashkin, A.O., Turchin, M.Y., Khadyev, V.T. & Shilko, E.V. (2022). Computer simulation of supporting layers of steel ladle lining influence on localization and growth direction of thermal cracks. *Novie ognepupry*, 10, 3 – 15. (*In Russian*).
- Gutkin, M.Yu., Ovidko, I.A. & Skiba, N.V. (2007). Effect of inclusions on heterogeneous crack nucleation in nanocomposites. *Physics of the Solid State*, 49, 261–266. <https://doi.org/10.1134/S1063783407020138>
- Kingery, W.D. (1960). *Introduction to ceramics*. New York: Wiley.
- Kuliev V.D. & Morozov E.M. (2016). *Doklady Physics*, 61, 502-504.



- Lee, W.E., & Moore, R.E. (1998). Evolution of in situ refractories in the 20th century, *Journal of the American Ceramic Society*, 81, 1385–1410. <https://doi.org/10.1111/j.1151-2916.1998.tb02497.x>
- Lu J. & Fleck N.A. (1998). The thermal shock resistance of solids. *Acta Materialia*, 46(13), 4755-4768. [https://doi.org/10.1016/S1359-6454\(98\)00127-X](https://doi.org/10.1016/S1359-6454(98)00127-X)
- Ning, J.G., Ren H.L. & Fang M. J. (2014). Research on the process of micro-crack damage evolution and coalescence in brittle materials. *Engineering Failure Analysis*, 41, 65-72. <https://doi.org/10.1016/j.engfailanal.2013.08.001>
- Nomura, O. & Uchida, S. (2000). Heat-Transfer Analysis of Various Ladle Refractory Linings. Shinagawa Technical Report, 23-34.
- Perelmuter, M.N. (2020) Analysis of Crack Resistance of Interfaces Between Materials. *Mechanics of Solids*, 55, 536–551. <https://doi.org/10.3103/S0025654420040123>
- Romanov, A.E. & Vladimirov. V.I. (1992). In: *Dislocations in solids* / Ed. F.R.N. Nabarro. North Holland. Amsterdam. 9. 191.
- Sadik, C., Moudhen, O., El-Bouari, A. & El-Amrani, I.-E. (2016). Review on the elaboration and characterization of ceramics refractories based on magnesite and dolomite. *Journal of Asian Ceramic Societies*, 4(3), 219-233. <https://doi.org/10.1016/j.jascer.2016.06.006>
- Sajjadi S.H., Salimi-Majd D. & Ostad M.J. (2016) Development of a brittle fracture criterion for prediction of crack propagation path under general mixed mode loading. *Engineering Fracture Mechanics*, 155, 36-48. <https://doi.org/10.1016/j.engfracmech.2016.01.015>
- Shi, S., Li, G., Jiang, G., Xie, L. & Liu, J. (2013). Temperature and Thermal Stress Analysis of Refractory Products. *Sensors & Transducers*, 21, 53-57. [https://www.sensorportal.com/HTML/DIGEST/may\\_2013/Special\\_issue/P\\_SI\\_341.pdf](https://www.sensorportal.com/HTML/DIGEST/may_2013/Special_issue/P_SI_341.pdf)
- Zhu T., Li, Y., Sang, S. & Xie, Z. (2017). Fracture behavior of low carbon MgO–C refractories using the wedge splitting test. *Journal of the European Ceramic Society*, 37(4), 1789-1797. <https://doi.org/10.1016/j.jeurceramsoc.2016.11.013>
- Stueckelschweiger, M., Gruber, D., Jin, S. & Harmuth, H. (2019). Creep testing of carbon containing refractories under reducing conditions, *Ceramics International*, 45(8). 9776-9781. <https://doi.org/10.1016/j.ceramint.2019.02.013>
- Varshneya, A. K., Burlingame, N. H. & Schultze, W. H. (1990). Parallel Plate Viscometry to Study Deformation-Induced Viscosity Changes in Glass. *Glastechnische Berichte*, 63K, 447-459.
- Zabolotskii, A.V. (2011). Mathematical simulation of the thermal stability of magnesium oxide. *Refractories and Industrial Ceramics*, 52(3), 170 - 177. <https://doi.org/10.1007/s11148-011-9390-1>
- Zabolotskiy, A.V., Turchin, M.Y., Khadyev, V.T. & Migashkin, A.O. (2020). Numerical investigation of refractory stress-strain condition under transient thermal load. *AIP Conference Proceedings*, 2310, 020355. <https://doi.org/10.1063/5.0034479>
- Zabolotskiy, A.V., Turchin, M.Y., Khadyev, V.T., Migashkin, A.O. (2023). Simulation of Crack Nucleation in Homogeneous Material Containing Regularly Spaced Pores under the Action of Uniaxial Compression. *AIP Conference Proceedings*, (in press).